

55V, 200mA Low Dropout Voltage Linear Regulator

General Description

The DS8606 series are a group of low-dropout (LDO) voltage regulators offering the benefits of wide input voltage range, low dropout voltage, low power consumption, and miniaturized packaging.

Quiescent current of only 2.2 μ A makes these devices ideal for powering the battery-powered, always-on systems that require very little idle-state power dissipation to a longer service life.

The DS8606 series of linear regulators are stable with the ceramic output capacitor over its wide input range from 2V to 55V and the entire range of output load current (0mA to 200mA).

Features

- 2.2 μ A Ground Current at no Load
- $\pm 1\%$ Output Accuracy
- 200mA Output Current
- Wide Operating Input Voltage Range: 2V to 55V
- Dropout Voltage: 0.66V at 100mA / V_{OUT} 5V
- Support Fixed Output Voltage 1.8V, 3.3V, 5V, 9V, 12V
- Stable with Ceramic or Tantalum Capacitor
- Current Limit Protection
- Over-Temperature Protection
- SOT-89-3 Package Available

Applications

- Portable, Battery Powered Equipment
- Low Power Microcontrollers
- Laptop, Palmtops and PDAs
- Wireless Communication Equipment
- Audio/Video Equipment
- Car Navigation Systems
- Industrial Controls
- Weighting Scales
- Meters
- Home Automation

Pin Configurations

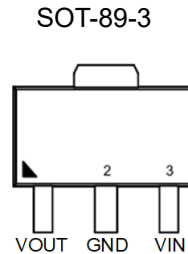

Ordering Information

DS8606-AABB

Designator	Description	Symbol	Description
AA	Output Voltage	18	$V_{OUT} = 1.8V$
	
	
		99	$V_{OUT} = 9.9V$
		A1	$V_{OUT} = 12V$
BB	Package type	A3	SOT-89-3

Special Request: Any Voltage between 1.8V and 12V under specific business agreement

Description of Functional Pins

Pin No	Pin Name	Pin Function
1	VOUT	Output of the Regulator
2	GND	Ground
3	VIN	Input of Supply Voltage.

Typical Application Circuits

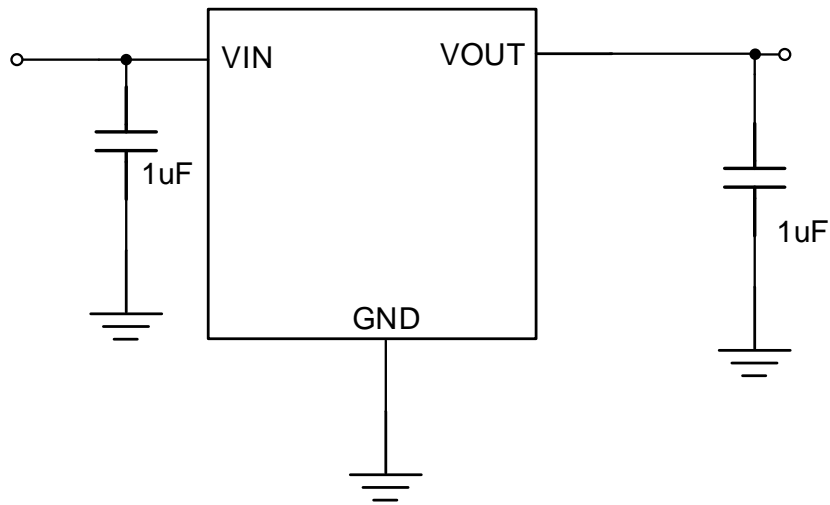
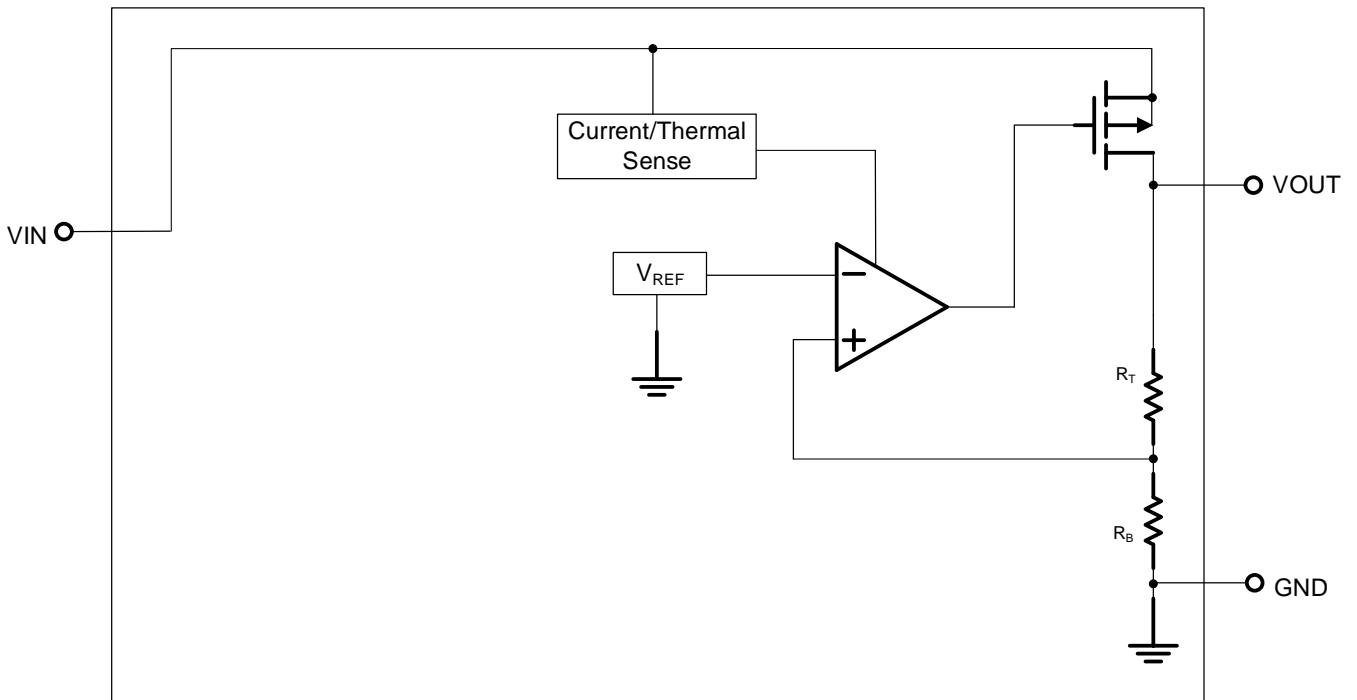

Figure 1: Application circuit of Fixed V_{OUT} LDO

Function Block Diagram



Absolute Maximum Ratings (Note 1)

VIN to GND	-----	-0.3V to 60V
VOUT to GND		
DS8606-A1, DS8606-90	-----	-0.3V to 14V
DS8606-18, DS8606-33, DS8606-50	-----	-0.3V to 6.0V
VOUT to VIN	-----	-60V to 0.3V
Package Thermal Resistance (Note 2)		
SOT-89-3, θ_{JA}	-----	120 °C /W
Lead Temperature (Soldering, 10 sec.)	-----	260 °C
Junction Temperature	-----	150 °C
Storage Temperature Range	-----	-60 °C to 150 °C
ESD Susceptibility		
HBM	-----	2KV
MM	-----	200V

Recommended Operating Conditions

Input Voltage VIN	-----	2.0V to 55V
Junction Temperature Range	-----	-40 °C to 125 °C
Ambient Temperature Range	-----	-40 °C to 85 °C

Electrical Characteristics

($V_{IN} = 15V$, $V_{EN} = 5V$, $T_A = 25^\circ C$ unless otherwise specified)

Parameter	Symbol	Test Conditions	Min	Typ	Max	Unit
Supply Voltage	V_{IN}		2	--	55	V
DC Output Voltage Accuracy		$I_{LOAD} = 0.1mA$	-1		1	%
Dropout Voltage ($I_{LOAD} = 100mA$)	V_{DROP}	$V_{OUT} \geq 5V$	--	0.66		V
	$V_{DROP_3.3V}$	$V_{OUT} = 3.3V$		0.75		
	$V_{DROP_1.8V}$	$V_{OUT} = 1.8V$		1		
Ground Current ($I_{LOAD} = 0mA$)	I_Q	$V_{OUT} \leq 5V$		2.2		μA
	I_{QH}	$5V < V_{OUT} \leq 12V$		4.2		
Line Regulation	Δ_{LINE}	$I_{LOAD} = 1mA$, $5 \leq V_{IN} \leq 55V$	--	0.3		%
Load Regulation	Δ_{LOAD}	$1mA \leq I_{LOAD} \leq 0.2A$		0.1		%
Output Current Limit	I_{LIM}	$V_{OUT} = 0$	201	300		mA
Power Supply Rejection Ratio	PSRR	$V_{OUT} = 5V$, $I_{LOAD} = 1mA$, $V_{IN} = 12V$, $f = 100Hz$		70		dB
Thermal Shutdown Temperature	T_{SD}	$I_{LOAD} = 10mA$	--	160	--	$^\circ C$
Thermal Shutdown Hysteresis	ΔT_{SD}				15	

Note 1. Stresses beyond those listed “Absolute Maximum Ratings” may cause permanent damage to the device. These are stress ratings only, and functional operation of the device at these or any other conditions beyond those indicated in the operational sections of the specifications is not implied. Exposure to absolute maximum rating conditions may affect device reliability.

Note 2. θ_{JA} is measured at $T_A = 25^\circ C$ on a DSTECH EVB board.

Typical Characteristics

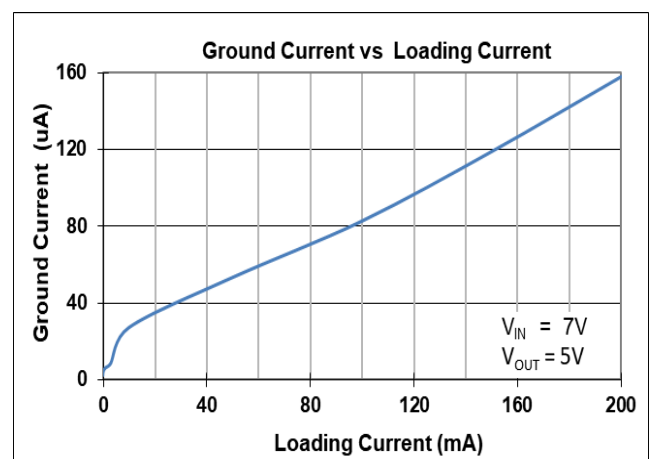
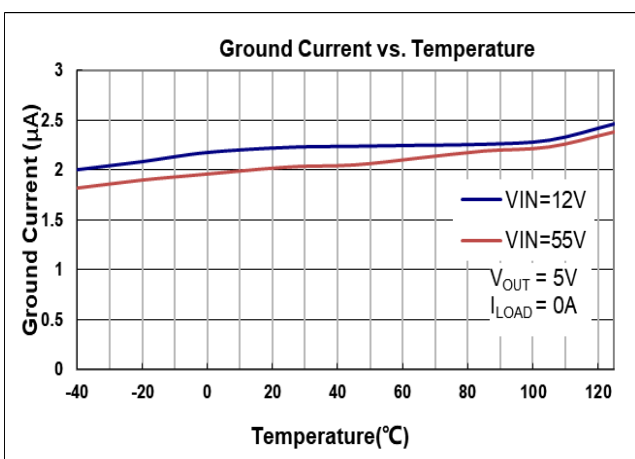
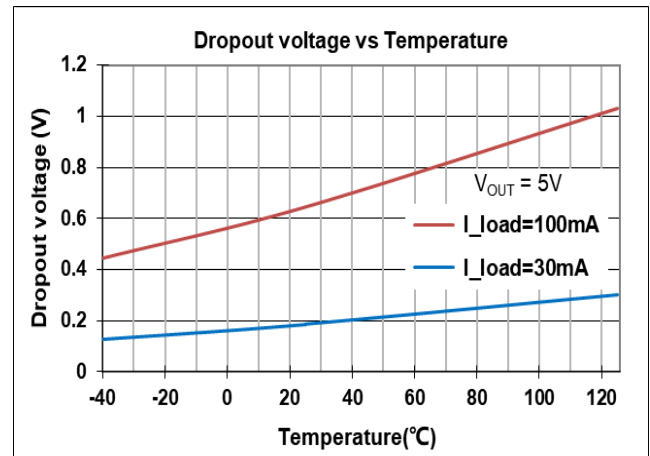
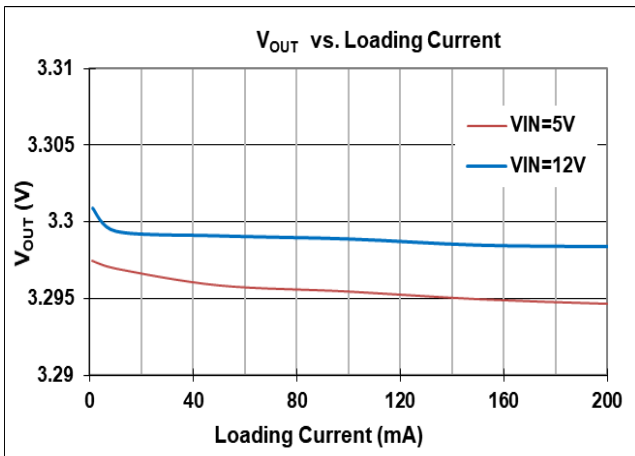
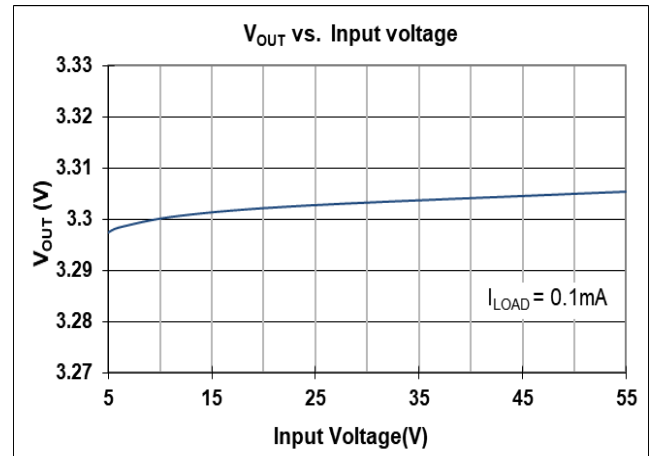
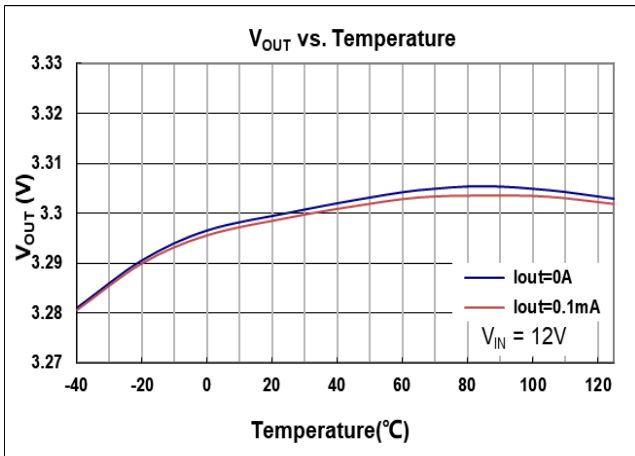

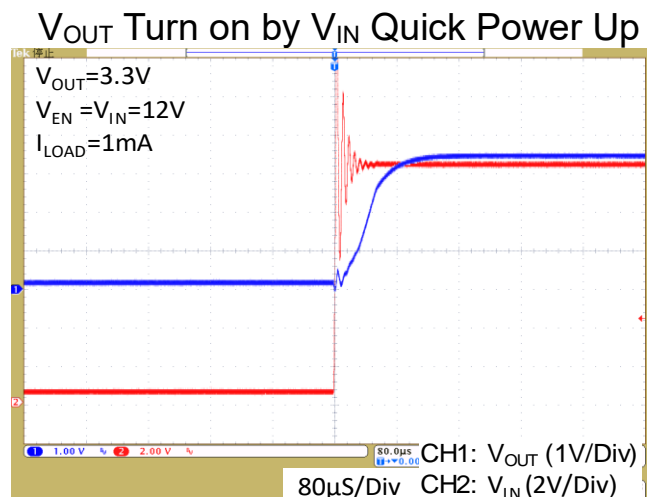
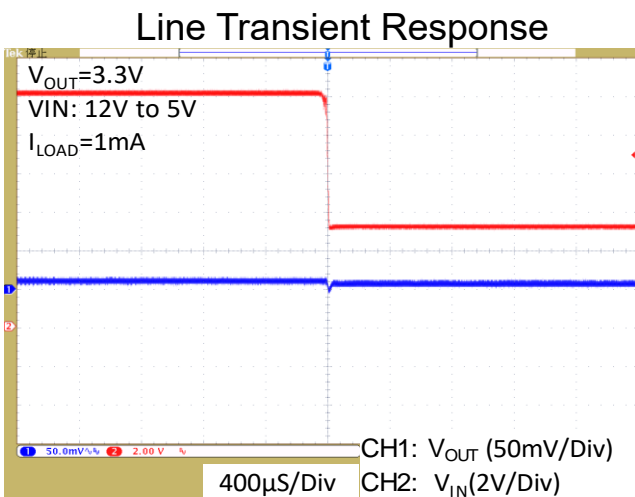
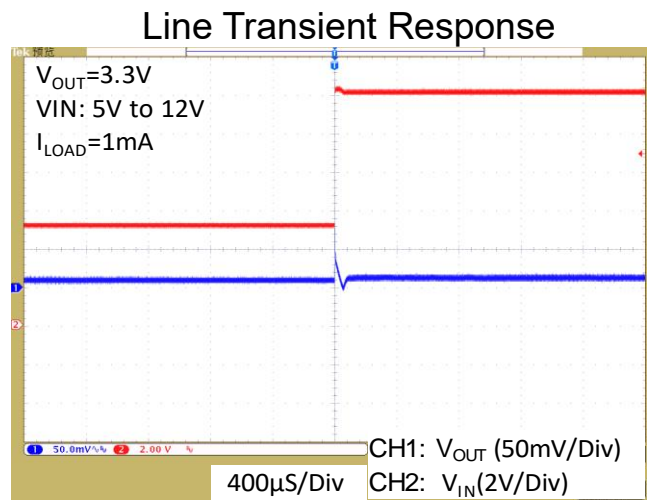
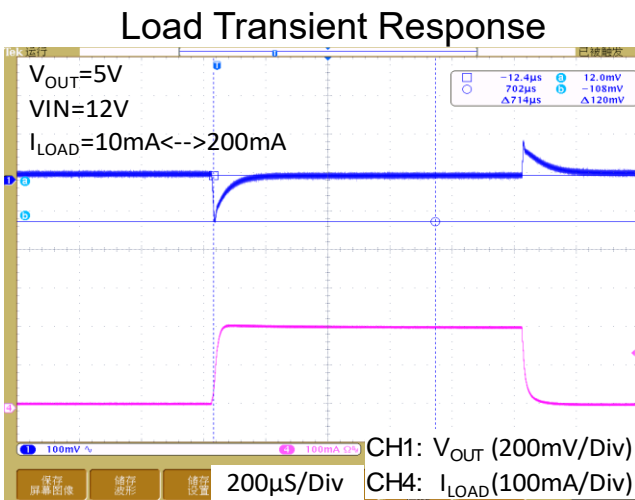
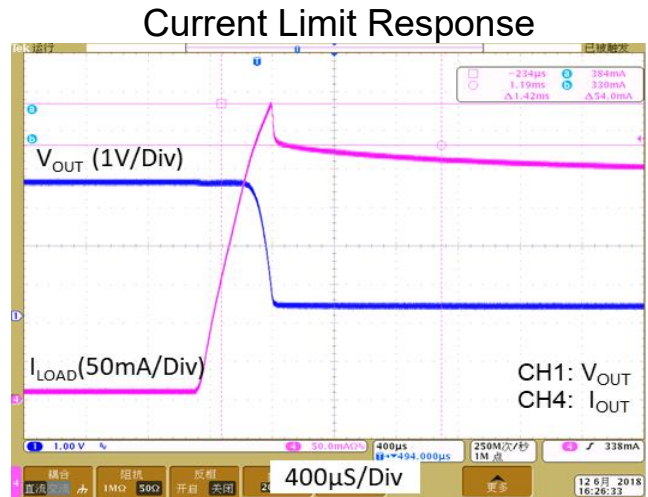
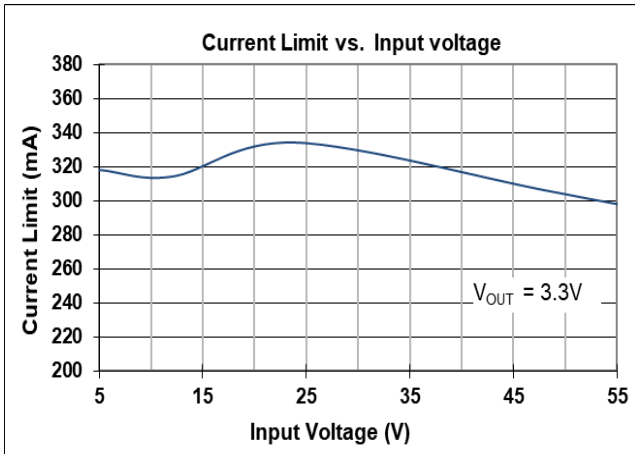

Input and Output Capacitor Requirements

The external input and output capacitors of DS8606 series must be properly selected for stability and performance. Use a 1 μ F or larger input capacitor and place it close to the IC's VIN and GND pins. Any output capacitor meeting the minimum 1m Ω ESR (Equivalent Series Resistance) and effective capacitance between 1 μ F and 22 μ F requirement may be used. Place the output capacitor close to the IC's VOUT and GND pins. Increasing capacitance and decreasing ESR can improve the circuit's PSRR and line transient response.

Current Limit

The DS8606 series contain the current limiter of output power transistor, which monitors and controls the transistor, limiting the output current to 300mA (typical). The output can be shorted to ground indefinitely without damaging the part.

Dropout Voltage

The DS8606 series use a PMOS pass transistor to achieve low dropout. When (VIN – VOUT) is less than the dropout voltage (V_{DROP}), the PMOS pass device is in the linear region of operation and the input-to-output resistance is the R_{DS(ON)} of the PMOS pass element. V_{DROP} scales approximately with the output current because the PMOS device behaves as a resistor in

dropout condition.

As any linear regulator, PSRR and transient response are degraded as (VIN – VOUT) approaches dropout condition.

OTP (Over Temperature Protection)

The over temperature protection function of DS8606 series will turn off the P-MOSFET when the junction temperature exceeds 160°C (typ.). Once the junction temperature cools down by approximately 15°C, the regulator will automatically resume operation.

Thermal Application

For continuous operation, do not exceed the absolute maximum junction temperature. The maximum power dissipation depends on the thermal resistance of the IC package, PCB layout, rate of surrounding airflow, and difference between junction and ambient temperature. The maximum power dissipation can be calculated as below:

T_A=25°C, DSTECH PCB,

The max PD (Max)= (125°C – 25°C) / (120°C/W) = 0.83W for SOT-89-3 package.

Power dissipation (PD) is equal to the product of the output current and the voltage drop across the output pass element, as shown in the equation below:

$$PD = (VIN - VOUT) \times IO_{OUT}$$

Layout Consideration

By placing input and output capacitors on the same side of the PCB as the LDO, and placing them as close as is practical to the package can achieve the best performance. The ground connections for input and output capacitors must be back to the DS8606 ground pin using as wide and as short of a copper trace as is practical.

Connections using long trace lengths, narrow trace widths, and/or connections through via must be avoided. These add parasitic inductances and resistance that results in worse performance especially during transient conditions.

Package Information:

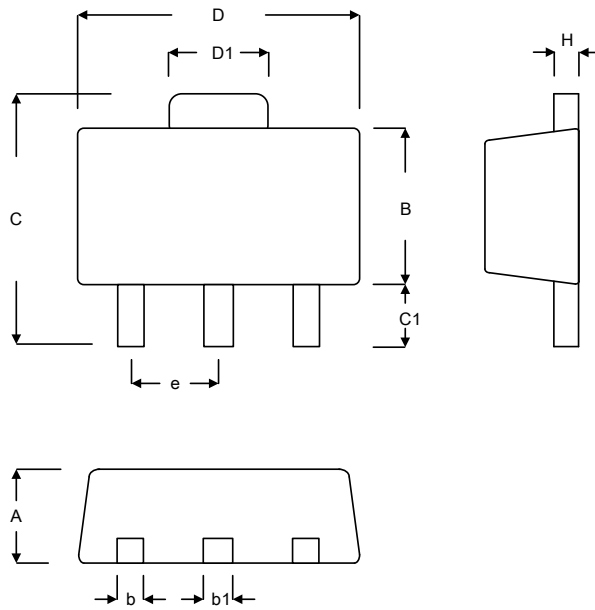

Symbol	Millimeters		Inches	
	Min.	Max.	Min.	Max.
A	1.397	1.600	0.055	0.063
b	0.356	0.483	0.014	0.019
B	2.388	2.591	0.094	0.102
b1	0.406	0.533	0.016	0.021
C	3.937	4.242	0.155	0.167
C1	0.787	1.194	0.031	0.047
D	4.394	4.597	0.173	0.181
D1	1.397	1.753	0.055	0.069
e	1.448	1.549	0.057	0.061
H	0.356	0.432	0.014	0.017

SOT-89-3L